

Data Sheet

DP-34045-3-000

xtremeDB

xDB-3-PNP

Passive Module

Common Ground

PNP Sensors

8-32 Vdc

**United States Patent:
US 10,069,226
Sep. 4, 2018**

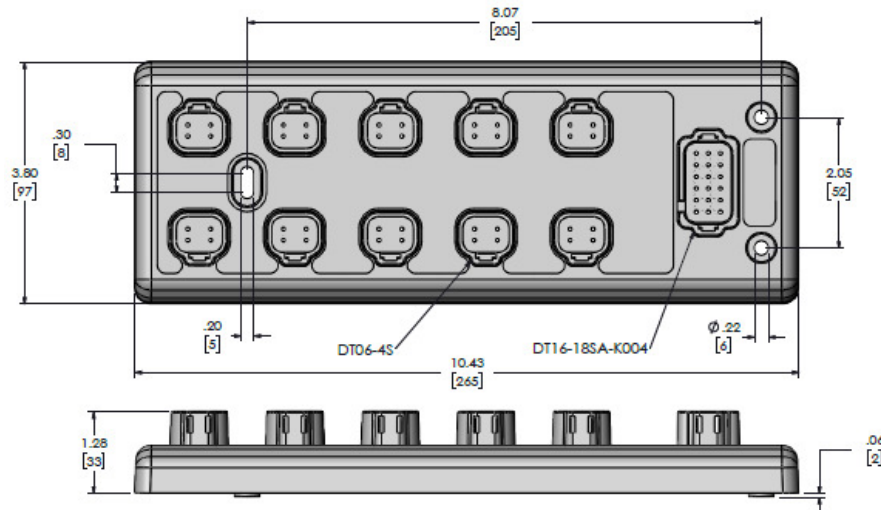

Technical Data

<i>Housing</i>	Molded plastic
<i>Dimensions (l x w x h)</i>	3.80 x 10.43 x 1.34 inch (97 x 265 x 34 mm)
<i>Weight</i>	1.5 lbs (0.68 kg)
<i>Installation (mounting hardware not included)</i>	Screw: 3 x #10 (3 x M5) Torque: 21 in-lbs (2.4 Nm) max.
<i>Mating Connectors and Accessories Operating Voltage, Ground, and Configuration I/O-Ports</i>	18 Pole Plug DT16-18SA or equivalent 4 Pole Plug 10 x DT06-4S or equivalent
<i>DEUTSCH size 20 Socket DEUTSCH size 16 Socket DEUTSCH Seal Plug</i>	0462-201-20141 0462-201-16141 114017-ZX
<i>Total I/O</i>	16 (2 mirrored ports: ports 7 & 9 and ports 8 & 10)
<i>Operating Voltage (IO)</i>	8...32 V DC
<i>Switching Current</i>	13 A per pin max.
<i>Total Current (Ground)</i>	26 A max.
<i>Total Current (IO)</i>	8 A max.
<i>Operating Temperature</i>	-40...80 °C
<i>Storage Temperature</i>	-40...85 °C
<i>IP67</i>	Connector seal plugs required for unused pins. Sealing plugs required for unused ports.



				Date	Name	Data Sheet xtremeDB Passive Module xDB-3-PNP	Art. No.: DP-34045-3-000	<i>Sheet</i> 1 of 4	
				Originator	02.10.17				JNa
				Approved	02.10.17				KGu
d	DCN F256	05.18.20	FSa	 A Murrelektronik Company					
c	DCN F112	12.02.19	FSa						
Rev.	Description	Date	Name						
b	Initial release	02.10.17	JNa	DP-34045-3-000_db_e_d.docx	The trademark DEUTSCH is owned by the TE Connectivity Ltd. family of companies.				

Operating States (LEDs)	Color	Status
OUT	Yellow	Left LED – Output A Right LED – Output B

Test Standards and Regulation

Climatic Tests	Temperature Shock to EN 60068-2-14:2000-08
Mechanical Tests	Vibration to JDQ 53.3 6.1.1 & 6.1.2, level 4 Shock to EN 60068-2-27:2009, test Ea Bump to EN 60068-2-29:2009, test Eb IP protection to EN 60529:2000-09, test IP67
CE	RoHS: Directive 2011/65/EU

Derating Curve

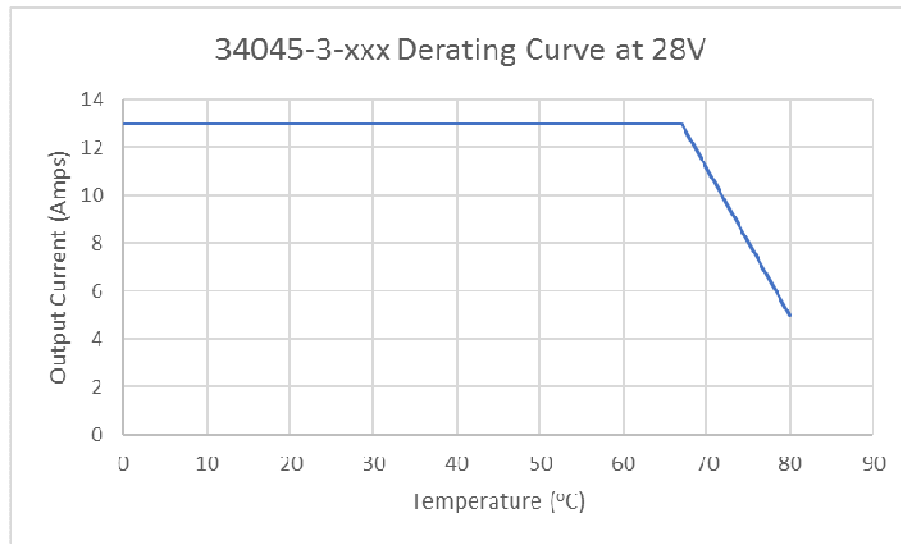

				Date	Name	Data Sheet xtremeDB Passive Module xDB-3-PNP	
			Originator	02.10.17	JNa		
			Approved	02.10.17	KGu		
d	DCN F256	05.18.20	FSa	 A Murrelektronik Company		Art. No.: DP-34045-3-000	Sheet 2 of 4
c	DCN F112	12.02.19	FSa				
Rev.	Description	Date	Name				
b	Initial release	02.10.17	JNa	DP-34045-3-000_db_e_d.docx	The trademark DEUTSCH is owned by the TE Connectivity Ltd. family of companies.		

Connector Interface

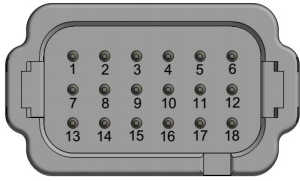

Connections:

1. Port 1, Pin 4: IO-1A
2. Port 1, Pin 2: IO-1B
3. Port 2, Pin 4: IO-2A
4. Port 2, Pin 2: IO-2B
5. Port 3, Pin 4: IO-3A
6. Port 3, Pin 2: IO-3B
7. Port 4, Pin 4: IO-4A
8. Port 4, Pin 2: IO-4B
9. Port 5, Pin 4: IO-5A
10. Port 5, Pin 2: IO-5B
11. Port 6, Pin 4: IO-6A
12. Port 6, Pin 2: IO-6B
13. Port 7 & 9, Pin 4: IO-7A
14. Port 7 & 9, Pin 2: IO-7B
15. Port 8 & 10, Pin 4: IO-8A
16. Port 8 & 10, Pin 2: IO-8B
17. Ground
18. Ground

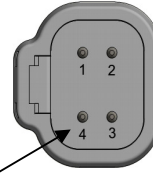
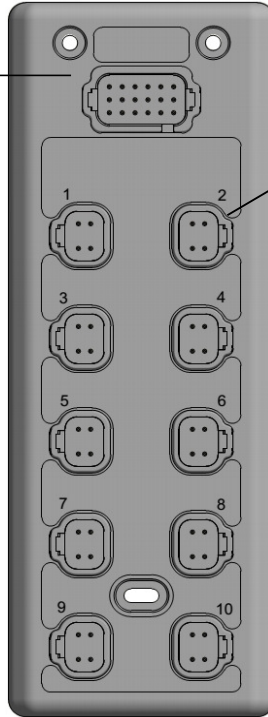

Connections:

Power Ports 1 to 10
 Pin 1 = Ground
 Pin 3 = Ground

Input/Output Ports 1 to 10

Port 1, Pin 4: IO-1A
 Port 1, Pin 2: IO-1B

Port 2, Pin 4: IO-2A
 Port 2, Pin 2: IO-2B

Port 3, Pin 4: IO-3A
 Port 3, Pin 2: IO-3B

Port 4, Pin 4: IO-4A
 Port 4, Pin 2: IO-4B

Port 5, Pin 4: IO-5A
 Port 5, Pin 2: IO-5B

Port 6, Pin 4: IO-6A
 Port 6, Pin 2: IO-6B

Port 7 & 9, Pin 4: IO-7A
 Port 7 & 9, Pin 2: IO-7B

Port 8 & 10, Pin 4: IO-8A
 Port 8 & 10, Pin 2: IO-8B

				Date	Name	Data Sheet xtremeDB Passive Module xDB-3-PNP		
				Originator	02.10.17			JNa
				Approved	02.10.17			KGu
d	DCN F256	05.18.20	FSa	 A Murrelektronik Company		Art. No.: DP-34045-3-000	Sheet 3 of 4	
c	DCN F112	12.02.19	FSa					
Rev.	Description	Date	Name					
b	Initial release	02.10.17	JNa	DP-34045-3-000_db_e_d.docx		The trademark DEUTSCH is owned by the TE Connectivity Ltd. family of companies.		

Connector Wire Diagram

34045-3-000 I/O Diagram

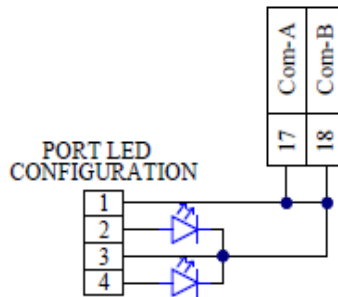
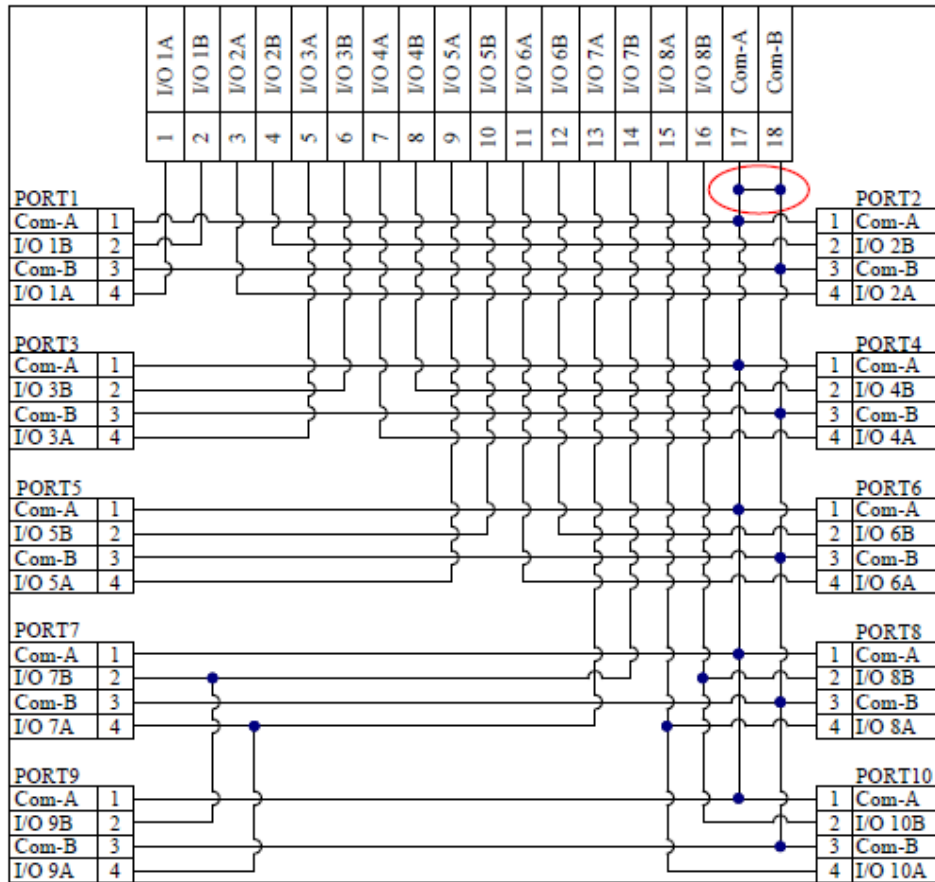

				Date	Name	Data Sheet xtremeDB Passive Module xDB-3-PNP Art. No.: DP-34045-3-000				
				Originator	02.10.17					JNa
				Approved	02.10.17					KGU
d	DCN F256	05.18.20	FSa	 A Murrelektronik Company			Sheet			
c	DCN F112	12.02.19	FSa				4 of 4			
Rev.	Description	Date	Name							
b	Initial release	02.10.17	JNa	DP-34045-3-000_db_e_d.docx	The trademark DEUTSCH is owned by the TE Connectivity Ltd. family of companies.					