

Data Sheet

DP-34045-5-000

xtremeDB

xDB-5-16IO

Passive Module

w/o LEDs

Common Bus

8-32 Vdc

**United States Patent:
US 10,069,226
Sep. 4, 2018**

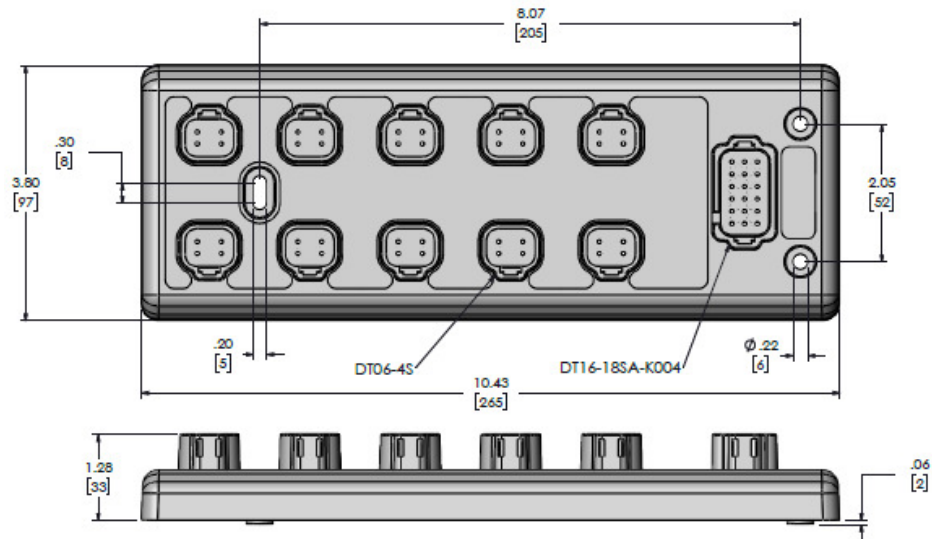

Technical Data

Housing	Molded plastic
Dimensions (l x w x h)	3.80 x 10.43 x 1.34 inch (97 x 265 x 34 mm)
Weight	1.5 lbs (0.68 kg)
Installation (mounting hardware not included)	Screw: 3 x #10 (3 x M5) Torque: 21 in-lbs (2.4 Nm) max.
Mating Connectors and Accessories Operating Voltage, Ground, and Configuration I/O-Ports	18 Pole Plug DT16-18SA or equivalent 4 Pole Plug 10 x DT06-4S or equivalent
DEUTSCH size 20 Socket	0462-201-20141
DEUTSCH size 16 Socket	0462-201-16141
DEUTSCH Seal Plug	114017-ZX
Total I/O	16 (2 mirrored ports: ports 7 & 9 and ports 8 & 10)
Operating Voltage (Common)	8...32 V DC or Ground
Switching Current	13 A per pin max.
Total Current (Common)	26 A max.
Total Current (IO)	8 A max.
Operating Temperature	-40...80 °C
Storage Temperature	-40...85 °C
IP67	Connector seal plugs required for unused pins. Sealing plugs required for unused ports.





				Date	Name	Data Sheet xtremeDB Passive Module xDB-5-16IO	Art. No.: DP-34045-5-000	Sheet 1 of 4	
				Originator	11.30.17				JNa
				Approved	11.30.17				VJi
d	DCN F256	05.18.20	FSa	 A Murrelektronik Company					
c	DCN F112	12.02.19	FSa						
Rev.	Description	Date	Name						
b	initial release	11.30.17	JNa	DP-34045-5-000_db_e_d.docx	The trademark DEUTSCH is owned by the TE Connectivity Ltd. family of companies.				

Test Standards and Regulation

<i>Climatic Tests</i>	<i>Temperature Shock to EN 60068-2-14:2000-08</i>
<i>Mechanical Tests</i>	<i>Vibration to JDQ 53.3 6.1.1 & 6.1.2, level 4 Shock to EN 60068-2-27:2009, test Ea Bump to EN 60068-2-29:2009, test Eb IP protection to EN 60529:2000-09, test IP67</i>
<i>CE</i>	<i>RoHS: Directive 2011/65/EU</i>

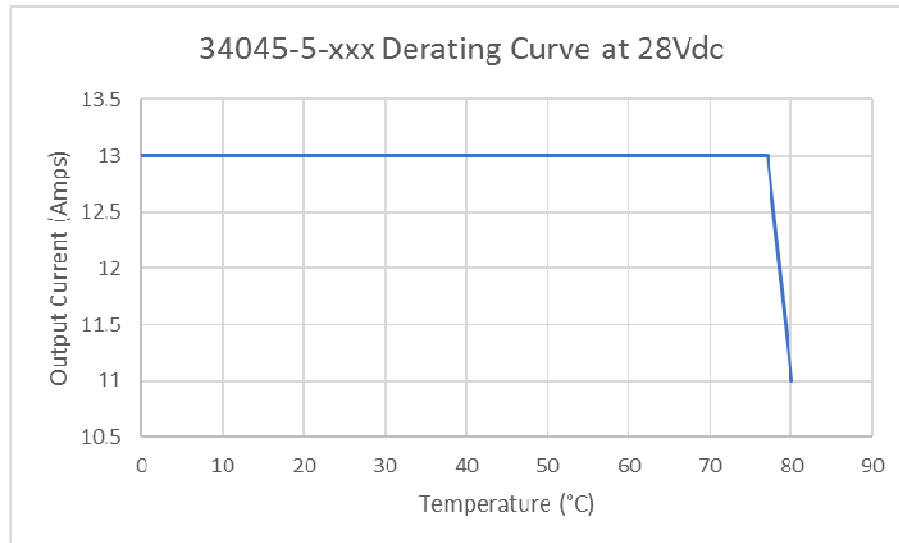
Derating Curve



				Date	Name	Data Sheet xtremeDB Passive Module xDB-5-16IO	
			Originator	11.30.17	JNa		
			Approved	11.30.17	VJi		
d	DCN F256	05.18.20	FSa	 A Murrelektronik Company		Art. No.: DP-34045-5-000	<i>Sheet</i> 2 of 4
c	DCN F112	12.02.19	FSa				
Rev.	Description	Date	Name				
b	initial release	11.30.17	JNa	DP-34045-5-000_db_e_d.docx	The trademark DEUTSCH is owned by the TE Connectivity Ltd. family of companies.		

Connector Interface

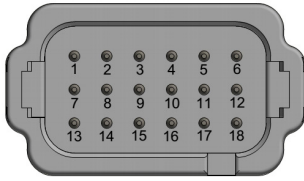

Connections:

1. Port 1, Pin 4: Output 1A
2. Port 1, Pin 2: Output 1B
3. Port 2, Pin 4: Output 2A
4. Port 2, Pin 2: Output 2B
5. Port 3, Pin 4: Output 3A
6. Port 3, Pin 2: Output 3B
7. Port 4, Pin 4: Output 4A
8. Port 4, Pin 2: Output 4B
9. Port 5, Pin 4: Output 5A
10. Port 5, Pin 2: Output 5B
11. Port 6, Pin 4: Output 6A
12. Port 6, Pin 2: Output 6B
13. Port 7 & 9, Pin 4: Output 7A
14. Port 7 & 9, Pin 2: Output 7B
15. Port 8 & 10, Pin 4: Output 8A
16. Port 8 & 10, Pin 2: Output 8B
17. Common
18. Common

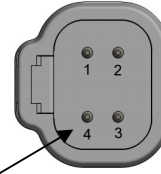
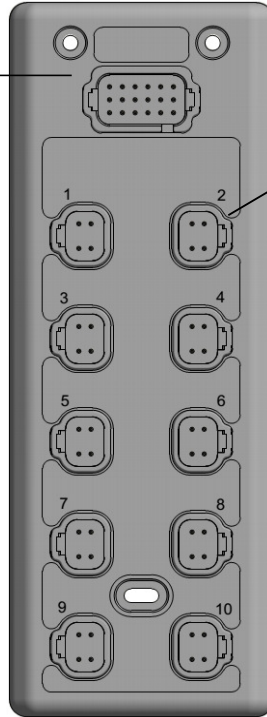

Connections:

Power Ports 1 to 10
 Pin 1 = Common
 Pin 3 = Common

Input/Output Ports 1 to 10

Port 1, Pin 4: Output 1A
 Port 1, Pin 2: Output 1B

Port 2, Pin 4: Output 2A
 Port 2, Pin 2: Output 2B

Port 3, Pin 4: Output 3A
 Port 3, Pin 2: Output 3B

Port 4, Pin 4: Output 4A
 Port 4, Pin 2: Output 4B

Port 5, Pin 4: Output 5A
 Port 5, Pin 2: Output 5B

Port 6, Pin 4: Output 6A
 Port 6, Pin 2: Output 6B

Port 7 & 9, Pin 4: Output 7A
 Port 7 & 9, Pin 2: Output 7B

Port 8 & 10, Pin 4: Output 8A
 Port 8 & 10, Pin 2: Output 8B

				Date	Name	Data Sheet xtremeDB Passive Module xDB-5-16IO		
				Originator	11.30.17			JNa
				Approved	11.30.17			VJi
d	DCN F256	05.18.20	FSa	 A Murrelektronik Company			Art. No.: DP-34045-5-000	
c	DCN F112	12.02.19	FSa					
Rev.	Description	Date	Name	DP-34045-5-000_db_e_d.docx			Sheet	
b	initial release	11.30.17	JNa				The trademark DEUTSCH is owned by the TE Connectivity Ltd. family of companies.	

Connector Wire Diagram

34045-5-000 I/O Diagram

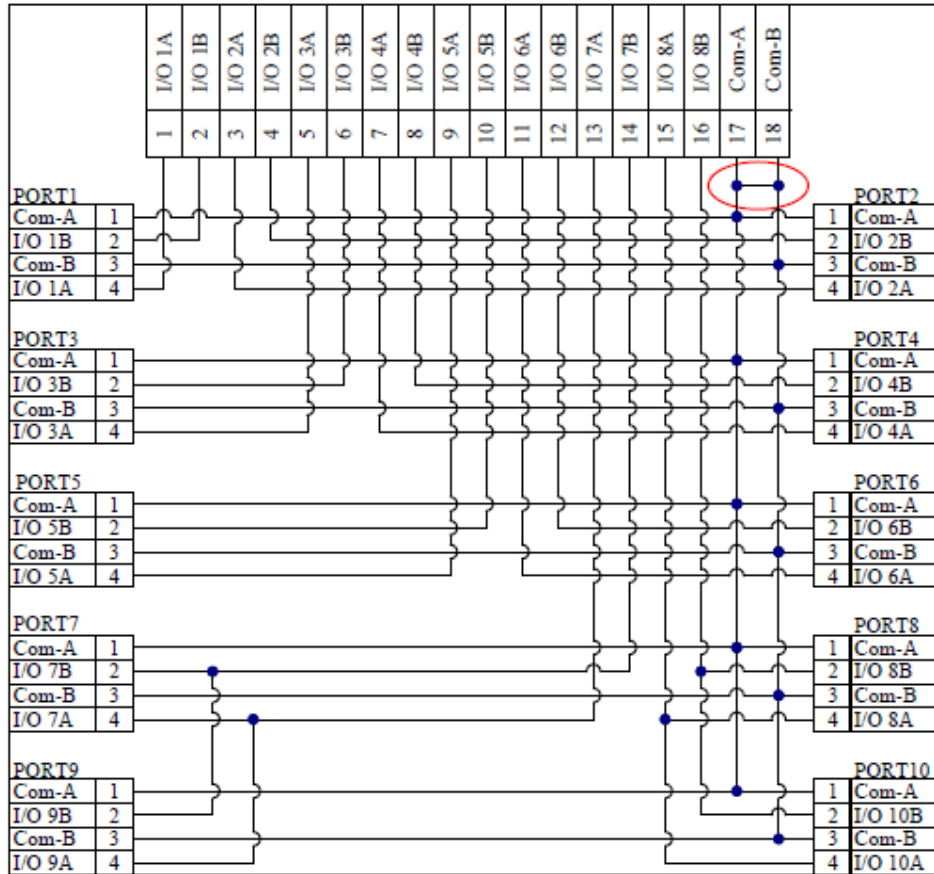

**PORT LED
CONFIGURATION**

NO LEDs

					Date	Name	Data Sheet xtremeDB Passive Module xDB-5-16IO	
				Originator	11.30.17	JNa		
				Approved	11.30.17	VJi		
d	DCN F256	05.18.20	FSa	 A Murrelektronik Company			Art. No.: DP-34045-5-000	Sheet 4 of 4
c	DCN F112	12.02.19	FSa					
Rev.	Description	Date	Name					
b	initial release	11.30.17	JNa	DP-34045-5-000_db_e_d.docx	The trademark DEUTSCH is owned by the TE Connectivity Ltd. family of companies.			